

ANGLE	± 5°	REV	LOCAS	DESCRIPTION	DESIGN	DATE	卫国峰
X.XXX	± 0.05	01			DRAWN	DATE	尚伟
X.XX	± 0.15	02			CHECKED	DATE	吴汉学
X.X	± 0.25	03			AUDITED	DATE	龚劲松
X	± 0.50	04			APPROVED	DATE	eric

Specifications/备注 (Remark)

1-材料 (MATERIAL)

胶芯: PA9T UL94V-0

Housing: PA9T UL94V-0

端子 (焊片): 磷青铜 (黄铜)

Contact (Solder tab): Phosphor bronze (Brass)

2-特性 (characteristics):

额定电压: 100V AC/DC .

Voltage Rating: 100V AC/DC .

额定电流: 1 AMP (AWG #28-32) .

Rating Current: 1 AMP (AWG #28-32) .

接触阻抗: ≤ 10mΩ MAX.

Contact Resistance: ≤ 10mΩ MAX.

绝缘阻抗: ≥ 500MΩMIN.

Insulating Resistance: ≥ 500MΩMIN.

耐电压: 800V AC/MINUTE

Withstanding Voltage: 800V AC/MINUTE

温度范围: -25度至+85度

Temperature Range: -25°C to +85°C

ORDERING INFORMATION

W35-XX XX X XX X

NO.OF PINS Per Row	INSULATOR MATERIAL	PACKING
02P	A: PA46	A: PE Bag
SERLES NO	B: PA66	B: TUBE
35: 3.5mm	C: PA9T	C: TRAY
	D: LCP	
CONTACT PLATING	CONTACT SHAPE	
FULL OF GOLD SEMI-GOLD	S: Straight	
A0=0.8u" B0=0.8u"	R: Right Angle	
... ..	LT: STRAIGHT SMT	
A9=30u" B9=30u"	WT: RIGHT ANGLE SME	
S1=ORDINARY TIN PLATED		
S2=MATTE TIN PLATED		
S3=TIN-PLATED HIGH-TEMPERATURE		

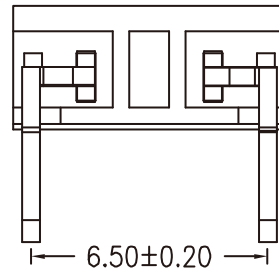
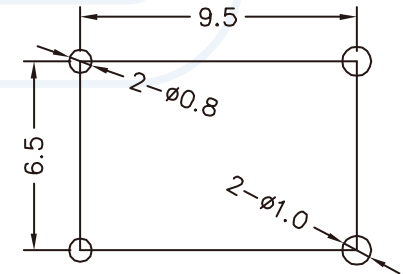
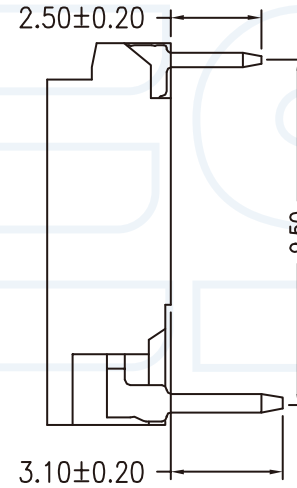
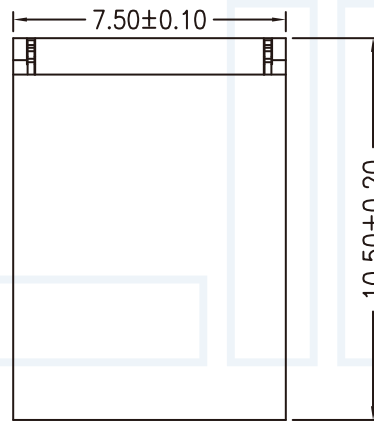
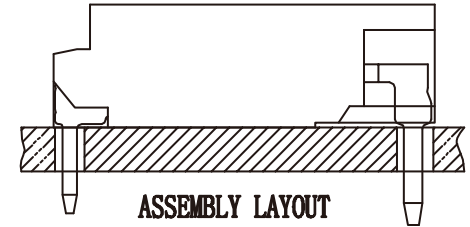
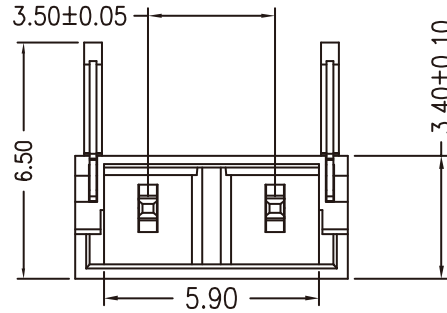

YLIES 东莞市瑞翔精密连接器有限公司
DONG GUAN YLIES PRECISE CONNECTOR CO.,LTD

Tel: 0769-85381995 / Fax: 0769-85493987 / Email: ylies@ylies.cn / Web: www.ylies.cn

TITLE

412-3.5mm 高压插针2P 插针90度 (BHD)

DATE

2018-02-18

PROJECTON

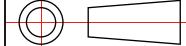

REV

A

UNIT

mm

SCALE

1:1

PAGE

1/1

PART NO:

W35-02S1BRB

DRAWING NO:

1

2

3

4

5

6

7

8

9